

Mifa

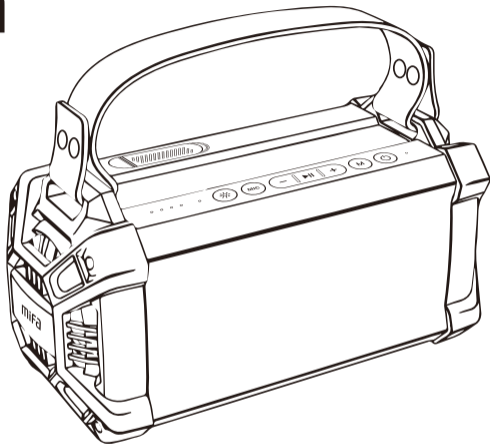

WILDROCK

QUICK START GUIDE

PACKING CONTENT

包装内容

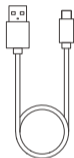
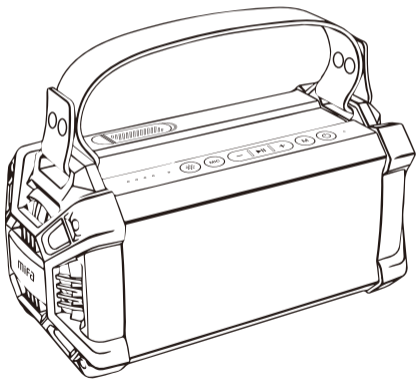

mifa



WILDROCK

QUICK START GUIDE

mifa



POWER ON

开关机

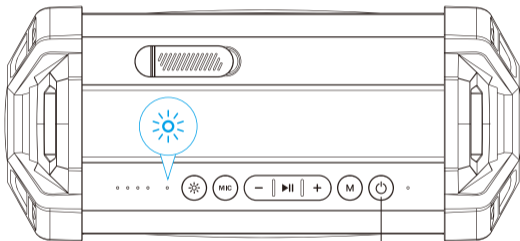

X1 ON/OFF

BLUETOOTH CONNECTION

蓝牙连接

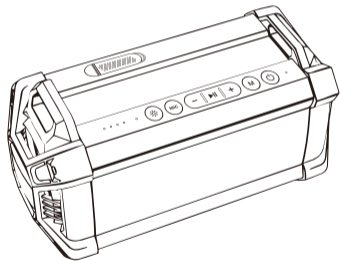

Pairing
配对状态



Connected
连接状态

1

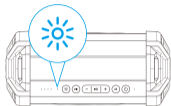

2



3



4

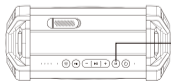

>2"



MODE SWITCH

模式切换

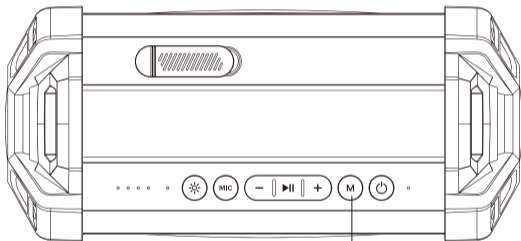

PLAY

播放控制

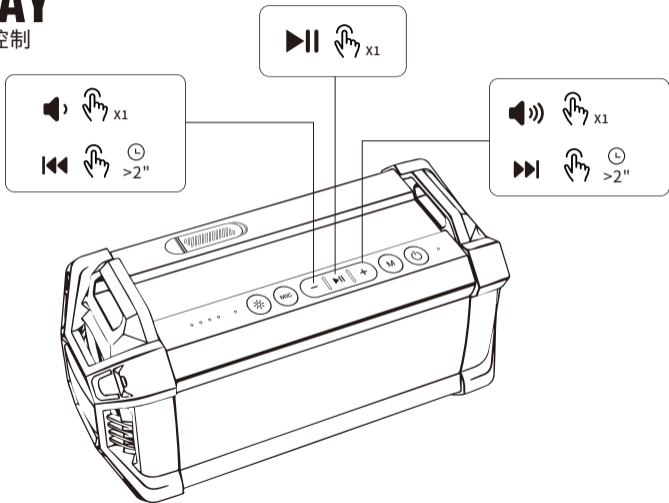

HANDS-FREE CALL

蓝牙通话

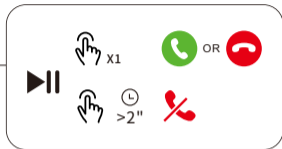
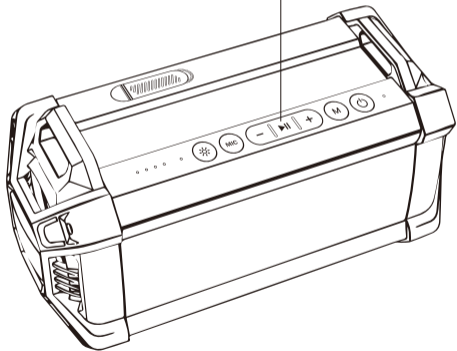

LIGHT

灯光模式

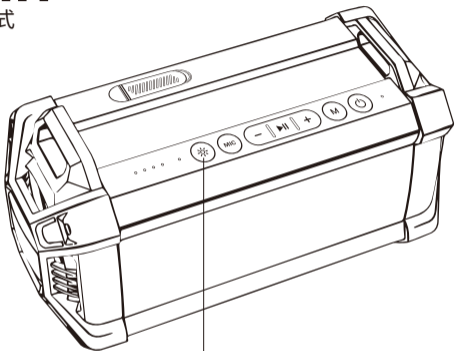

X1



>2"

OFF

MIC

话筒

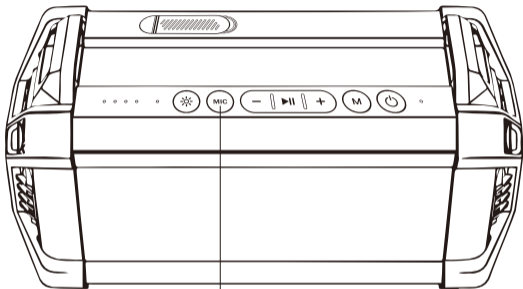

x1

Microphone Priority ON/OFF

话筒优先开/关



>2"

Microphone UHF Connected /Disconnected

话筒UHF连接或断开

MICROPHONE

话筒功能



			Press and hold for 1.5 seconds to power on/off
		>1.5"	长按1.5秒开或关
			Press and hold to turn up the volume
			长按话筒音量增大
			Press and hold to turn down the volume
			长按话筒音量减小
		X1	Short press to switch the Echo mode
			短按混响模式切换

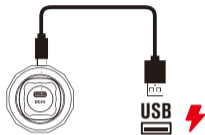

频段显示CH01-CH10
Frequency band Display:
CH01-CH10

短按 频段加一级
Short press + to plus

短按 频段减一级
Short press - to minus

*The UHF connection is enabled by default when the speaker is turned on. If you want to connect the second microphone, please check the channel of the first one, if the channel of the first one is CHA, then switch the channel of the second microphone to CHB.

*音箱开机默认开启UHF连接功能，话筒开机后会自动与音箱连接，如需连接第二支话筒时，请查看第一支话筒使用的通道，如第一支话筒使用的是CHA通道，第二支话筒请切换到CHB通道。

A/B frequency band switch:

Press and hold the " " button at the same time under the power-off status, it will display CHB or CHA and power on in 3 seconds.

A/B麦频段切换：话筒关机状态下，同时按住电源键和+键，3秒后显示CHB或CHA并开机。

CHARGE

充电



USB



Built-in reset button:

Press the reset button in the jack with a needle to reset speaker.

内置复位键：可用细棒按压，系统复位关机

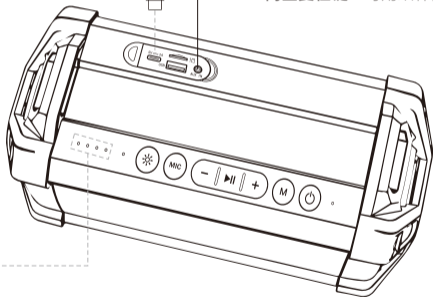

• • • • 100%



• • • 75%

• • 50%

• 25%



FAQ 疑难解答

故障 Problems	解决方法 How to solve
使用话筒信号不好或有卡顿时	可通过短按“+”或“-”，选择合适的频段：CH01~CH10，以获取最佳效果
话筒不能与主机连接时	话筒在开机状态下，同时按住“电源键”和“-”屏上显示DE，恢复默认设置重新与主机连接
话筒无法开机	请插上充电线充电激活
标配话筒遗失或坏掉了，新配的话筒如何与音箱配对ID?	音箱关机，话筒开机，同时长按话筒的“电源键”和“+”键，屏显示ID符号，进入对ID状态。 此时音箱立即开机即可自动配对ID。（连接成功后，音箱会有连接成功提示音）
如何清除话筒的ID?	话筒：开机状态，同时按电源键和“-”键，屏显示DE符号，这时话筒返回到无ID状态。 注意：如果话筒清除了ID，需要再次与音箱连接时，按新配的话筒方法重新配对ID。
When the signal of the microphone is not good or is stuck,	Short press “+” “-” to select the appropriate frequency band from CH01-CH10.
When the microphone cannot be connected to the host	Press and hold the “  ” and “-” simultaneously in the power-on state, then “DE” will be displayed on the screen, it will restore to the default settings and reconnect.
If the microphone cannot be turned on	please plug in the charging cable to charge and activate;
How to pair with a new microphone?	While the speaker in power-off state, microphone in power-on state, press and hold the “  ” and “+” button of the microphone simultaneously, the screen will display the “ID” and enter the ID pairing status. At this time, the speaker can be automatically paired with the ID when it is turned on. (After the connection is successful, the speaker will have a beep).
How to clear the ID of the microphone?	Microphone: Press the “  ” and “-” simultaneously in the power-on state, then “DE” will be displayed on the screen, it will restore to non ID status. Note: If the microphone has cleared its ID and needs to be connected to the speaker again, re-pair the ID according to the method of the new microphone.

ZH-CN

技术规格

扬声器:	2 x 3英寸全频扬声器
无源辐射器:	90mm x 2pcs
信噪比:	> 89dB
电池类型:	锂电池(3.7V 4500mAh) x 2
充电接口:	USB Type-C
电池充电时间:	约4.5小时 (5V/3A)
音乐播放时间:	约 13小时 (取决于音量和音频内容, 动态灯光OFF)
蓝牙版本:	5.0
蓝牙通话:	支持
可播放格式:	MP3、WMA、WAV、FLAC、APE(Micro SD Card/U盘)
动态灯光:	RGB氛围灯
扩音功能:	支持无线麦克风扩音功能
产品尺寸:	W307mm* H150.5mm* D140mm / W12.08" xH 5.92" x D5.51"
产品重量:	约1773g

EN

Technical Specification

Speaker:	2 x 3 inch full-range speaker
Passive Radiators:	90mm x 2pcs
SNR:	> 89dB
Battery type:	Lithium battery (3.7V 4500mAh) × 2
Charging interface:	USB Type-C
Charging time of battery:	Approx.4.5 hours (5V/3A)
Music playing time:	Approx.13 hours (depending on volume and audio content, with dynamic light off)
Bluetooth version:	5.0
Hands-free call:	Yes
Playable format:	MP3、WMA、WAV、FLAC、APE(Micro SD Card/U disk)
Dynamic light:	RGB ambient lighting
Amplifier function:	Support wireless micropone amplifi cation function
Dimension of product:	W307mm* H150.5mm* D140mm / W12.08" xH 5.92" x D5.51"
Weight of product:	1773g

JP

技術仕様

スピーカー:	2x3インチフルレンジスピーカー
パッシブラジエーター:	90mm x 2
Sn比:	>89dB
バッテリーの種類:	リチウムバッテリー (3.7V 4500mAh) x2
充電コネクタアプリ:	USB Type-C
バッテリー充電時間:	約4.5時間(5V/3A)
音楽再生時間:	約13時間 (音量や再生内容により異なります,ダイナミックライトOFF)
Bluetoothバージョン:	5.0
ハンズフリーコール:	はい
対応プロファイル:	MP3、WMA、WAV、FLAC、APE(Micro SD Card/U disk)
ダイナミックライト:	RGBアンビエントライト
アンプ機能:	ワイヤレスマイク増幅機能をサポート
製品寸法:	W307mm* H150.5mm* D140mm / W12.08" xH 5.92" x D5.51"
製品重量:	1773g

DE

Technische Spezifikation

Lautsprecher:	2 x 3 Zoll Volllautsprecher
Passive Strahler:	90mm x 2
SNR:	>89dB
Batterietyp:	Lithiumbatterie (3,7 V 4500 mAh) × 2
Aufladeschnittstelle:	USB Typ-C
Aufladezeit der Batterie:	ca. 4.5 Stunden (5V/3A)
Spielzeit der Musik:	ca. 13 Stunden (je nach Lautstärke und Audioinhalt, mit dynamischem Licht aus)
Bluetooth-Version:	5.0
Hände frei:	Yes
Abspielbares Format:	MP3, WMA, WAC, FLAC, APE (MicroSD-Karte/U-Festplatte)
Dynamisches Licht:	RGB-Ambientebeleuchtung
Verstärkerfunktion:	Unterstützt die drahtlose Mikrofonverstärkungsfunktion
Dimension des Produkts:	B307 mm * H 150,5 mm * T 140 mm / B 12,08 " × H 5,92" × T 5,51"
Produktgewicht:	1773g

FR

Spécification technique

Haut-parleur:	2 haut-parleurs large bande de 3 pouces
Radiateurs passifs:	90mm x 2
SNR:	>89dB
Type de batterie:	batterie au lithium (3.7V 4500mAh) × 2
Interface de recharge:	USB Type-C
Temps de recharge de batterie:	environ 4.5 heures (5V/3A)
Temps de lecture de musique:	environ 13 heures (selon le volume et le contenu audio, avec la lumière dynamique éteinte)
Version Bluetooth:	5.0
Appel mains libres :	Yes
Format lisible:	MP3, WMA, WAC, FLAC, APE (Carte MicroSD/Disque U)
Lumière dynamique:	éclairage d'ambiance RVB
Fonction amplificateur	Support wireless microphone amplification fonction
Dimension de produit:	W307mm* H150.5mm* D140mm / W12.08" xH 5.92" x D5.51"
Poids de produit:	1773g

ES

Especificaciones técnicas

Altavoces:	Altavoz de rango completo de 2 x 3 pulgadas
Radiadores Pasivos:	90mmx 2
SNR:	>89dB
Tipo de batería:	Batería de litio (3,7V 4.500mAh) × 2
Interfaz de carga:	USB Tipo-C
Tiempo de carga de la batería:	Aproximadamente 4.5 horas (5V/3A)
Tiempo de reproducción de música:	Aproximadamente 13 horas (según el volumen y el contenido de audio, con la luz dinámica apagada)
Versión de Bluetooth:	5,0
Formato de reproducción:	MP3, WMA, WAC, FLAC, APE (Tarjeta Micro SD/disco U)
Luz dinámica:	Iluminación ambiental RGB
Función de amplificador:	Admite la función de amplificación de micrófono inalámbrico
Dimensión del producto:	W307mm* H150.5mm* D140mm / W12.08" xH 5.92" x D5.51"
Peso del producto:	1773g

IT

Specifiche Tecniche

Altoparlante:	Altoparlante full range da 2 x 3 pollici
Radiatori Passivi:	90mm x 2
SNR:	> 89 dB
Tipo di batteria:	Batteria al litio (3,7V 4500 mAh) × 2
Interfaccia di ricarica:	USB Tipo C
Tempo di ricarica della batteria:	Circa 4.5 ore (5V / 3 A)
Tempo di riproduzione della musica:	Circa 13 ore (a seconda del volume e del contenuto audio, con luce dinamica spenta)
Versione Bluetooth:	5.0
Formato riproducibile:	MP3, WMA, WAC, FLAC, APE (Scheda Micro SD/disco U)
Luce dinamica:	illuminazione ambientale RGB
Funzione amplificatore:	Supporta la funzione di amplificazione del microfono wireless
Dimensioni del prodotto:	L 307 mm * A 150,5 mm * P 140 mm / L 12,08" × A 5,92 × P 5,51"
Peso del prodotto:	1773g

RU

Технические характеристики

Динамик:	2 x 3-дюймовый полнодиапазонный динамик
Пассивный источник:	90mm x 2
Отношение сигнал к шуму:	89 дБ
Тип батареи:	литиевая батарея (3,7В 4500 мАч) × 2
Интерфейс зарядки:	USB Type-C
Время зарядки аккумулятора:	около 4.5 часов (5В/3А)
Время воспроизведения музыки:	около 13 часов (в зависимости от громкости, аудиоконтента и при отключенном динамическом освещении)
Версия Bluetooth:	5.0
Форматы воспроизведения:	MP3, WMA, WAV, FLAC, APE (Карта Micro SD/U диск)
Динамическая подсветка:	окружающее освещение RGB
Функция усилителя:	Поддержка функции усиления беспроводного микрофона
Размеры устройства:	307мм*150,5мм*140мм/12,08” × 5,92” × 5,51”
Вес устройства:	1773 грамм

This device complies with part 15 of the FCC Rules. Operation is subject to the following two conditions: (1) this device may not cause harmful interference, and (2) this device must accept any interference received, including interference that may cause undesired operation.

Any changes or modifications not expressly approved by the party responsible for compliance could void the user's authority to operate the equipment.

NOTE: This equipment has been tested and found to comply with the limits for a Class B digital device, pursuant to Part 15 of the FCC Rules. These limits are designed to provide reasonable protection against harmful interference in a residential installation. This equipment generates, uses and can radiate radio frequency energy and, if not installed and used in accordance with the instructions, may cause harmful interference to radio communications. However, there is no guarantee that interference will not occur in a particular installation.

If this equipment does cause harmful interference to radio or television reception, which can be determined by turning the equipment off and on, the user is encouraged to try to correct the interference by one or more of the following measures:

- Reorient or relocate the receiving antenna.
- Increase the separation between the equipment and receiver.
- Connect the equipment into an outlet on a circuit different from that to which the receiver is connected.
- Consult the dealer or an experienced radio/TV technician for help. The device has been evaluated to meet general RF exposure requirement. The device can be used in portable exposure condition without restriction

FCC ID: 2AXOX-WILDROCK

mifa MIFA INNOVATIONS LLC
www.mifa.net Designed in US Made in China

Copyright © MIFA. All rights reserved.
MIFA, the MIFA logo and other MIFA marks are all owned and registered by MIFA INNOVATIONS LLC. All other trademarks are the property of their respective owners. The information contained here is subject to change without prior notice.



JUST ENJOY